

Data Sheet



Article number: 20881M1815200MSM

Description: E+G
Breather valve, - M18x1.5

Measures

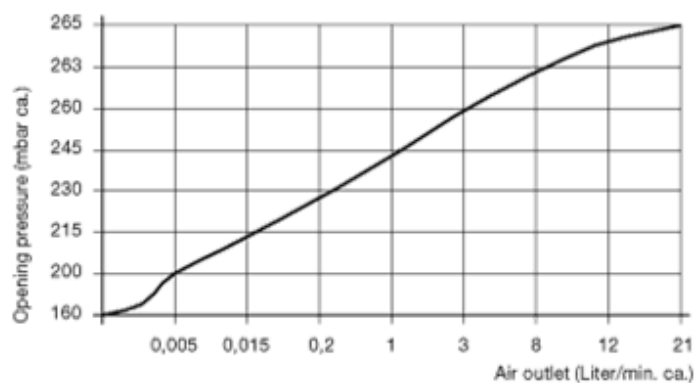
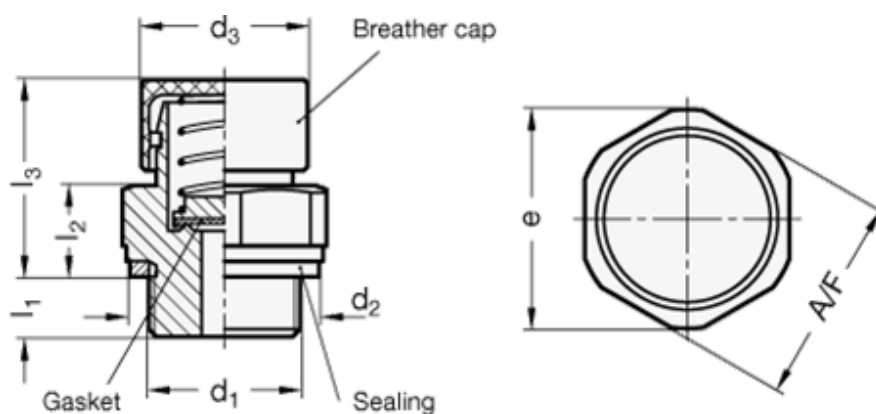

A/F	= 22
d2	= 24
d3	= 22
e	= 23.5
l1	= 8.5
l2	= 11.5
l3	= 26.5
Thread d1	= M18x1.5